

IRB 4400

Fast, compact and versatile industrial robot



IRB 4400 is an extremely fast, compact robot for medium to heavy handling. It has exceptional all-round capabilities which makes it suitable for a variety of manufacturing applications. The load capacity of 60 kg at very high speeds usually permits handling of two parts at a time.

Fast, compact and versatile industrial robot

IRB 4400 is a rigid, well-balanced design and patented TrueMove™ function provide smooth and fast movement throughout the entire working range. This ensures very high quality in applications such as cutting. Rapid maneuverability makes the IRB 4400 perfectly matched for applications where speed and flexibility are important. The compact design and protected versions enables use in situations where conventional robots cannot work, such as foundry and spraying applications. The Foundry Plus 2 version is IP 67 protected and can be washed with high pressure steam, which makes it ideal for use in harsh environments.

Reliability and economy

The robust, rigid construction means long intervals between routine maintenance. Well-balanced steel arms with double bearing joints, a torque-strut on axis 2 and use of maintenance-free gearboxes and cabling also contribute to the very high levels of reliability. The drive train is optimised to give high torque with the lowest power consumption for economic operation.

Extensive communication for easy integration

The extensive communication capabilities include serial links, network interfaces, PLC, remote I/O and field bus interfaces. This makes for easy integration in small manufacturing stations as well as large scale factory automation systems.

Global service and support

For worry-free operation, ABB also offers Remote-Service, which gives remote access to equipment for monitoring and support. Moreover, ABB customers can take advantage of the company's service organization; with more than 35 years of experience in the arc welding sector, ABB provides service support in over 100 locations in 53 countries.

Main Applications

- Cutting/Deburring
- Die Spraying
- Dispensing
- Grinding/Polishing
- Measuring

Specification

Robot version	Reach (m)	Handling capacity (kg)
IRB 4400/60	1.96	60
IRB 4400/L10	2.53	10
Supplementary load		
on axis 2	35 kg	
on axis 3	15 kg	
on axis 4	0-5 kg	
Number of axes	6	
Protection	Standard version IP 54, Foundry Plus 2 IP 67 and high pressure steam washable	
Mounting	Floor	
Controller	IRC5 Single Cabinet	
Integrated signal supply	23 signals and 10 power on upper arm	
Integrated air supply	Max. 8 bar on upper arm	

Performance (according to ISO 9283)

	Position repeatability	Path repeatability*
IRB 4400/60	0.19 mm	0.56 mm
IRB 4400/L10	0.05 mm	0.16 mm

*At 1.6 m/s.

Technical information

Electrical Connections

Supply voltage	200-600 V, 50/60 Hz
Rated power transformer rating	7.8 kVA

Physical

Robot base	920 x 640 mm
Robot weight	1040 kg

Environment

Ambient temperature for mechanical unit	
During operation	+5° C (41° F) to + 45° C (113° F)
Relative humidity	Max. 95%
Noise level	Max. 70 dB (A)
Safety	Double circuits with supervision, emergency stops and safety functions, 3-position enable device

Emission	EMC/EMI-shielded
----------	------------------

Data and dimensions may be changed without notice.

Movement

Axis movement	Working range	Axis max speed IRB 4400/60	Axis max speed IRB 4400/L10
Axis 1, Rotation	+165° to -165°	150°/s	150°/s
Axis 2, Arm	+95° to -70°	120°/s	150°/s
Axis 3, Arm	+65° to -60°	120°/s	150°/s
Axis 4, Rotation	+200° to -200°	225°/s	370°/s
Axis 5, Bend	+120° to -120°	250°/s	330°/s
Axis 6, Turn	+400° to -400°	330°/s	381°/s
	Max. rev: +200° ¹ to -200° ²		

¹Max. rev: +183 to -183 valid for IRB 4400/L10

²The default working range for axis 6 can be extended by changing parameter values in the software.

There is a supervision function to prevent overheating in applications with intensive and frequent movements.

Working range, IRB 4400/60

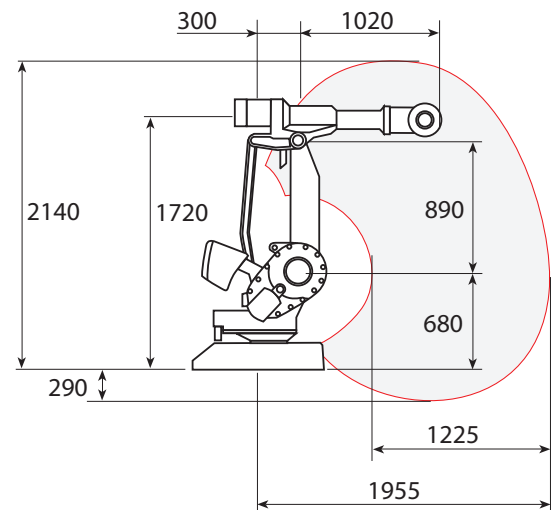

Working range, IRB 4400/L10

